

Waydoo Flyer EVO

USER GUIDES | MANUALS | SAFETY

V1.0 2024.06

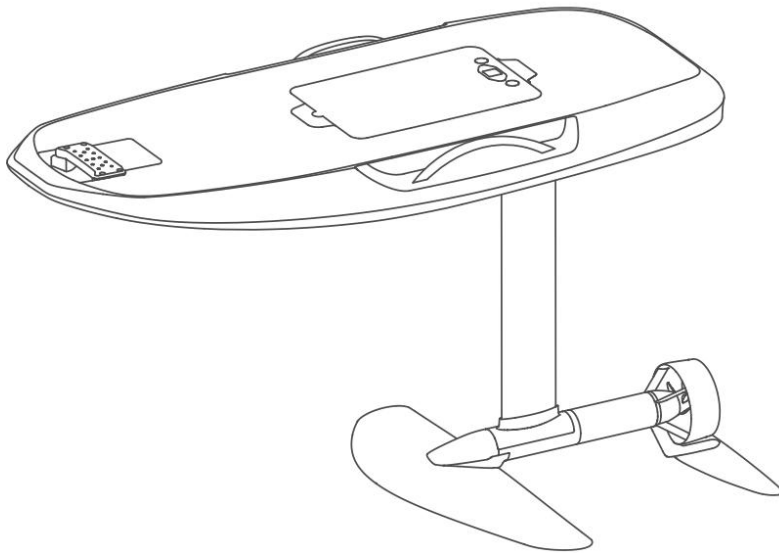

Content

I Disclaimer	1
II Safety Guidelines	2
III Product Introduction	7
3.1 Product Overview	7
3.2 Product Combinations	7
IV Assembly and use	26
4.1 Waydoo Flyer EVO Assembly	26
4.2 How to use	31
V Troubleshooting	33
VI Maintenance	34
VII Warranty Terms	42

I Disclaimer

Please fully read this product manual and related warnings and Safety Guidelines carefully before use. Please fully understand your legal rights, responsibilities, and safety instructions. This product concerns water sports equipment. Improper use may cause the risk of severe injury or death. USE THIS PRODUCT AT YOUR OWN RISK. Users must understand and accept the inherent risks of using this product. Any misuse of this product may cause personal injury or property/product damage. When using this product, please be sure to use original accessories or Waydoo certified accessories. By using this product, you are deemed to have accepted the terms and content of this document in its entirety. Users are responsible for their actions and all consequences. As the developer of this product, Waydoo reserves the right to change components, specifications, or other information without prior notice. For the latest information, please visit www.waydootech.com

WARNING: NOT FOR USE BY CHILDREN. Minors under the age of 18 should not use this product. A safety summary is included as part of the Safety Guidelines. Please read the entire content of this manual and the Safety Guidelines carefully. After reading the entire user manual, familiarize yourself with the functions of the product before proceeding. Failure to operate this product properly may cause serious injury to yourself or others and damage the product and property. This product can only be used safely with instructions clearly in mind, and it requires some basic common sense before operation. Do not use parts that are damaged, in need of maintenance or not provided or recommended by Waydoo, and strictly follow Waydoo's instructions to install and use the product. This guide contains instructions on safety, operation, and maintenance. Make sure to carefully read all instructions and warnings in the user guides before assembly, setup, and use.

II Safety Guidelines



Failure to follow the Safety Guidelines and warnings may result in serious injury or death.

1. Safety Summary

1. Refer to the user manual and watch the official instructional video (<https://www.youtube.com/c/Waydoo/featured>) to learn how to use this product safely.
2. This product can only be used on water. Take safety measures when using this product and wear a life jacket and safety helmet.
3. The use of this product requires a water depth of at least 1.5 meters (5 feet). Be aware of gravel, plants, or wild animals in the water.
4. When using the product, pay attention to the surrounding environment, stay away from the shore, and keep a safe distance from ships, other watercraft and other people.
5. Do not use this product in waters where there are swimmers or divers.
6. Do not use this product in waters with floating objects, obstacles, or many wild animals and plants.
7. Do not use damaged or malfunctioning products or parts.
8. Do not place the product directly on the roof of the car for transportation. Otherwise, the product may slide off and cause serious damage.
9. Do not use this product before fully understanding the operation steps and inherent risks of the product.
10. Do not allow others to use this product unless they fully understand the operation steps and inherent risks of the product.
11. Do not remove the propeller guard.
12. Do not attempt to fix or touch the propeller in the water.
13. Do not remove the battery when the product is in the water or wet.
14. Do not power on the Controller until in the water and ready for use. When the system is powered on, keep the propeller away from your body, fingers, and toes. The rotating propeller may cause serious, or even life-threatening, injury. Treat with caution.

15. When used in the water, any contact with the mast, front wing or stabilizer wing may cause serious, or even life-threatening, injury. Treat with caution.

16. Do not use this product in bad weather. Pay attention to changes in weather when using this product or around hazardous waters, such as riptides or undercurrents.

17. Always use this product steadily and safely. Do not perform dangerous operations such as over speeding or sharp turns.

18. Please ensure that the load limit of the product is not exceeded during use, otherwise the product may be damaged.

2. Things to Know Before Use

Before using this product, check the product to ensure that the waterproof components (such as the remote, the connectors, the battery, and the mast head) are not damaged, the power system and control system work normally, the battery power is sufficient, and the bolts of each component have been tightened. Do not use damaged products or parts.

1. Check whether the connection position of the power unit is firm and the bolts are tightened in place.
2. Make sure that the propeller and protective cover are not damaged or cracked, and carefully remove any sand or debris residue.
3. Install the Powerflight Battery in the designated location.
4. Make sure the Powerflight Battery is installed firmly and the lock is tightened in place.
5. Make sure the product is free of damage and is working properly before use.

3. Special Warning

To avoid possible injury and loss, be sure to observe the following.

1. The failure to use original or certified accessories may create a dangerous condition and result in personal injury or damage to the product.
2. No foreign matter (such as water, oil, sand, soil, etc.) has entered the interior of each component.

Propulsion Unit

ATTENTION:

1. Before use, make sure that the propeller and protective cover are not damaged or cracked, and carefully remove any sand or debris.

DANGER:

1. Do not remove the propeller guard.
2. Do not attempt to fix or touch the propeller in the water.
3. When the system is powered on, keep the propeller away from your body, fingers, and toes.
4. The rotating propeller may cause serious, or even life-threatening, injury. Treat with caution.

Mast

ATTENTION:

1. The use of the product requires a water depth of at least 1.5 meters (5 feet). Be careful of gravel, plants, or wild animals in the water.
2. When using the product, pay attention to the surrounding environment, stay away from the shore, and keep a safe distance from ships and others.
3. Before riding, confirm no water, sand, and /or debris inside the connector.
4. Avoid impact on the copper column of the mast, causing appearance damage.
5. Avoid impact on the mast head, causing appearance damage.
6. It is recommended to clean the ESC cooling cabin with fresh water after each use to prevent foreign matter and shellfish from corroding or blocking the water inlet and outlet.
7. Clean the mast DC port in time. Corrosion will affect the contact. If the corrosion is serious, the port shrapnel needs to be replaced.
8. After riding, rinse the product thoroughly with clean water.

WARNING:

When used in water, any contact with the mast, wings or spinning propeller may cause serious injury or death. Treat with caution.

Powerflight Battery

WARNING:

1. Do not disassemble or modify the Powerflight Battery for other purposes. Otherwise, the warranty will be invalid.
2. Do not disassemble, puncture, impact, or drop the Powerflight Battery.
3. Do not handle the Powerflight Battery with wet hands.
4. Do not install or remove the Powerflight Battery in water.
5. Do not discard the Powerflight Battery randomly. Disposal of lithium-ion batteries requires special handling and must be done in accordance with

local laws and regulations.

6. Do not expose the Powerflight Battery to direct sunlight, fire, or place it in an environment where the temperature exceeds 45°C (113°F).

7. ONLY Use the standard charger for charging.

8. Place the Powerflight Battery in a safe place and avoid contact with young children or animals.

9. Check whether the Powerflight Battery is normal before use. Using abnormal batteries may cause damage, electric shock, fire, and even life-threatening situations.

10. If you need to store the Powerflight Battery for more than one month, maintain the battery level at 40-60%.

11. The transportation of the Powerflight Battery needs to comply with relevant local laws and regulations.

4. Restrictions and Local Regulations

It is prohibited to use this product in waters where there are swimmers or divers. It is forbidden to operate in restricted traffic areas. Make sure to strictly abide by local laws and regulations.

5. After Use

1. After use, press and hold the power button of the remote for 3 seconds, and power off the remote.

2. Take the board out of the water and use the magnet to press and hold the power button of the Powerflight Battery for 3 seconds to turn off the Powerflight Battery. After confirming that it is turned off, unscrew the Rotary Locks and remove the Powerflight Battery.

3. Unscrew the Front Wing and Stabilizer Wing fixing bolts and remove the wings.

4. Unscrew the fixing bolts to uninstall the power unit.

5. Rinse off the sand and dirt from the Board and other parts with fresh water.

* The propulsion unit and mast are called a power unit when assembled.

Download Waydoo app

In order to better manage and enjoy the use of Waydoo Flyer EVO, Waydoo invites you to download and install the Waydoo app. This app will give you more features and control options for a better experience.



iOS



Android

III Product Introduction

3.1 Product Overview

The Waydoo Flyer EVO series is Waydoo's new generation of products. This series includes components like the Powerflight Battery, Propulsion Unit, Mast, Board, Remote, Hydrofoil Wing, Powerflight Charger, Powerflight Inverter Charger, Scooter Kit, etc. Users can freely choose and combine these components based on their specific usage needs to create a complete product.

3.2 Product Combinations

Users can choose different product combinations depending on the usage scenario. With simple assembly and disassembly, users can switch between different products quickly. The following provides an introduction to the Waydoo Flyer EVO eFoil.

Combination	Component	Optional Version
Waydoo Flyer EVO eFoil	Mast	27" Mast
		31" Mast Carbon
		35" Mast
	Propulsion Unit	Propulsion Unit Performance
		Propulsion Unit Standard
		Propulsion Unit Elite
	Powerflight Battery	Powerflight Battery 18
		Powerflight Battery 23
	Remote	EVO Remote
	Charger	Powerflight Charger
	Charging Inverter	Powerflight Inverter Charger

	Board	EPP Board	Max Plus 130L
			Pro/Pro Plus 90L
		Kevlar Board	Master Plus 75L
	Front Wing	Voyager G1500/C1500	
		Voyager G1100/C1100	
		Glider G1500/C1500	
	Stabilizer Wing	Gliding Tail 320	
		Surfing Tail 322	
	Propulsion Options	Standard Propeller	
		Jet Drive	
		Folding Propeller	
	Accessory Options	Board Bag	
		Mover-S	
		Mover-L	
		Scooter Kit	

3.2.1 Waydoo Flyer EVO eFoil

3.2.1.1 Component Introduction

Mast

Three masts with different heights and materials are available, which can be flexibly matched according to different usage scenarios.

The 27" Mast is suitable for beginners using it in calm waters, offering better maneuverability and control.

The 31" Mast Carbon is a mid-range length that suits a wide range of users.

The 35" Mast is more suitable for advanced users on the ocean, as it allows the board to rise higher above the water, easily gliding over waves.

Propulsion Unit

The propulsion units is available in three configurations: Propulsion Unit Performance, Propulsion Unit Standard, and Propulsion Unit Elite.

The Propulsion Unit Performance delivers a higher top speed, stronger power. Paired with the appropriate wings, suitable for users seeking to push their limits.

The Propulsion Unit Standard is more lightweight, portable, and offers a wide range of speeds, meeting most users' needs.

Board

The board is available in three sizes: Max Plus (130L), Pro/Pro Plus (90L), and Master Plus (75L).

Both the Pro/Pro Plus and Max Plus boards are made of EPP, which is more durable and collision-resistant than carbon fiber, greatly improving safety. With a capacity of 90 liters and 130 liters, and a length of 154 cm and 177 cm, respectively, they are a cost-effective choice. The Max Plus board can be equipped with an inflatable pod to provide greater buoyancy, which is very suitable for beginners to use during the practice stage.

The Master Plus board is made of Kevlar material, which has higher strength, better control performance and more beautiful appearance. It has a capacity of 75 liters and a length of 144 cm. The Master Plus board is more flexible and suitable for experienced and advanced users.

All versions of the board are equipped with an ergonomically designed handlebar at the front, which is designed to provide more convenient and stable hand support when boarding or lying on the board, which helps users better control and balance.

The version with Plus in the board name has multiple sensors and GPS built in, which can realize more intelligent functions. Compared with the board without GPS and sensors, the Plus board has the following advantages:

1. The GPS of the board can improve the accuracy of positioning and speed measurement data.
2. The built-in sensor can measure the height of the board from the water surface and provide flight assist function.
3. Through the sensors installed inside the board, the Waydoo flight management system can sense the surrounding environment and assist users to better control the flight.

Tips: Please note that the board has a built-in antenna device. Please avoid

the antenna position being blocked by external objects (such as body, metal, water, etc.), which will affect the reception and transmission performance of the antenna signal.

Front Wing

The Voyager series wing has good flexibility and brings you a better sense of sports participation.

The Glider series wing has a large aspect ratio, which is more efficient, energy-saving, easy to control, stable, has a longer endurance, and is suitable for long-distance cruising.

The Voyager G1500/C1500 has sufficient lift and flexibility.

The Voyager G1100/C1100 has a faster speed and is more flexible.

The Glider G1500/C1500 has a longer endurance and better stability, making it the best choice for beginners.

Stabilizer Wing

The stabilizer wing features small fins on both ends to enhance directional stability. It provides pitch stability with balanced performance, suitable for various wings and application scenarios. Using an extension rod improves stability.

Propulsion Options

Three propulsion options are available: Standard Propeller, Jet Drive, and Folding Propeller.

The Standard Propeller is equipped with a propeller guard and a protective cover, which can meet most of the user's needs.

The Folding Propeller is efficient and powerful, and it is more suitable for free riding in the wave area with a small board and a long mast. When the throttle is released, the blades will automatically close to reduce resistance.

The Jet Drive makes the propeller no longer exposed, which is not only safer, but also provides smooth and gentle power output. It is the best choice for beginners to practice.

Power Unit

The power unit consists of the mast, propulsion unit, propulsion component, front wing, and stabilizer wing. In normal use, the propulsion unit and propulsion component provide the necessary power, while the front wing and stabilizer wing offer lift and stability.

Board Bag

We also designed a special standard board bag for the Master Plus board.

Mover

Install the Mover-S on the Pro/Pro Plus board and install the Mover-L on the Max Plus board to facilitate the transportation of the product.

Remove the two screws pre-installed on the board, and then tighten the two L-shaped screws. Note: When using the board mover to transport the board, if the road is bumpy or there are steps, do not install or place the battery on the board, otherwise the mover rod may be damaged.

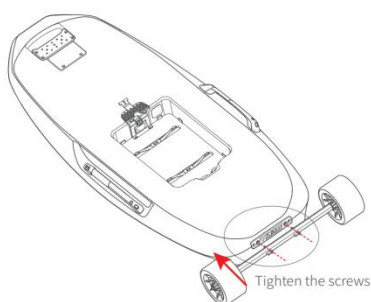

Scooter Kit

Transform your eFoiling experience with the EVO Scooter Kit, which introduces a scooter form to your Max Plus board. This kit comes with a handlebar that easily attaches to the board's nose, providing exceptional stability and control.

EVO remote

The EVO remote is ergonomically designed and equipped with an LCD display interface. The display shows the power level of the Powerflight battery and the EVO remote, flight speed, gear, GPS signal, Bluetooth connection status, etc. The remote provides 24 gears for adjustment. Use the gear "+" / "-" buttons on the remote to adjust the gears.

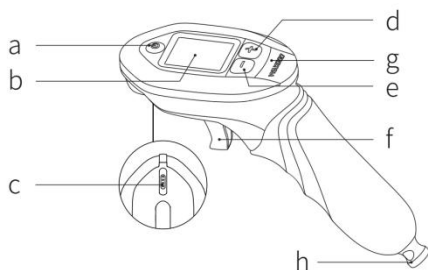

- a.Power Button(Return Button)
- b.LCD Display
- c.Magnetic Charging Port
- d."+" Speed Gear (Up Scroll Button)
- e."-" Speed Gear(Down Scroll Button)
- f.Trigger (Confirm Button)
- g.Indicator Light
- h.Battery Magnet

Turn EVO remote on/off

Press and hold the power button on the remote for 3 seconds to turn the remote on/off.

EVO remote charging

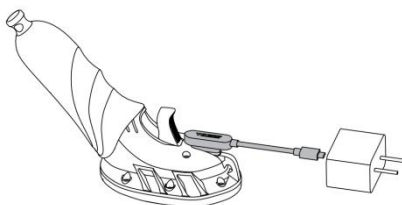

1. Plug in a USB charger and attach the magnetic charging plug to the EVO remote, ensuring the charging pins are connected.
2. When the remote is charging normally, the indicator light at the bottom will light up, and the charging time is about 2 hours (5V/2A charger).

Tips: When the power of the remote is less than 20%, a low-battery warning box appears, please charge it in time.

EVO remote connection

1. Press and hold the power button of the remote for about 3 seconds to turn on the remote.

2. Press and hold the power button and "-" speed gear button on the remote at the same time for 2 seconds to open the Bluetooth connection management interface.
3. In the Bluetooth connection management interface, a list of currently connectable boards will be displayed.
4. Use the "+" and "-" speed gear buttons to select the board to be connected.
5. Press the trigger to confirm to complete the remote connection.

EVO remote display interface

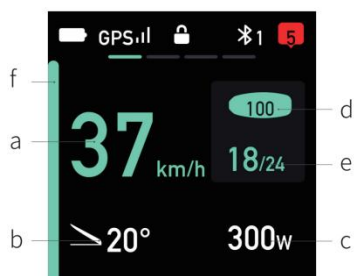

Main interface



- a. Current speed
- b. Current inclination angle
- c. Current power
- d. Powerflight battery power
- e. Gear information
- f. Throttle indication

Tips:

Color of Powerflight battery level symbol:

-  Yellow: No battery data
-  Green: Battery data available
-  Red: No battery data, Bluetooth is not connected

The battery level symbol will flash when the battery power is below 20%.

Status Bar

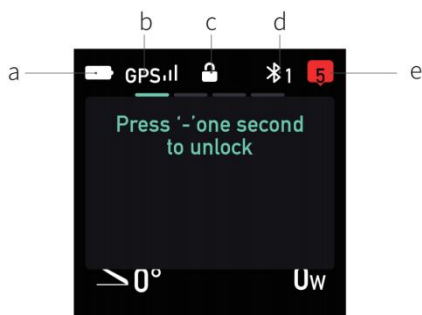

- a. Remote power: remaining battery power of the remote.
- b. GPS signal: current signal received by GPS.
- c. Whether the remote is in lock mode: whether the current remote is in lock mode.
- d. Bluetooth: Displays the number of Bluetooth connections.
- e. Notification prompt: If there is a notification message, it will be prompted through the notification prompt icon (The number represents the number of messages).

Tips:

1. To ensure safety, the remote throttle will be locked when the remote trigger is in the initial position for more than 7 seconds. At this time, the propeller will not rotate when the trigger is pressed. Press and hold the "-" button for about 1 second to unlock.
2. When the remote is in the setting mode, the propeller will not turn when the trigger is pressed.

Menu operation

In the settings mode, short press the power button to switch the main interface, which can also be used as the return button. The trigger serves as the confirm button, the "+" / "-" buttons are used as navigation buttons to up/down scroll. For example, if you need to reconnect the remote to the board via Bluetooth through the menu interface, the steps are as follows:

1. In the main interface, press the power button to switch the interface to the fourth screen in sequence.
2. Press the trigger to confirm and enter the current interface.
3. Press the "+" / "-" buttons to navigate to "BT".
4. Press the trigger to confirm and enter the Bluetooth scanning interface.

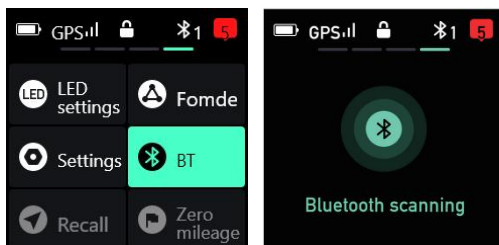

5. Press the "+" / "-" buttons to select the board you want to connect.
6. Press the trigger to confirm and it will prompt that the connection is successful.

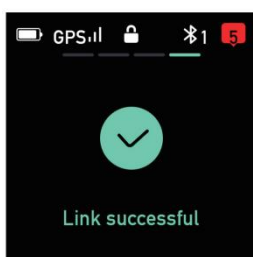

Tips:

- 1.If it is the first time to connect the remote, the remote screen will prompt you to go to the Powerflight Battery to confirm the connection. Please use a magnet to short tap on the power button of the Powerflight Battery once to confirm the connection.
- 2.After the connection is successful, the remote display will automatically return to the main interface.
- 3.If you press and hold the trigger when the remote is started, the throttle range of the trigger may become smaller or the confirmation button function may become invalid. If this happens, you can release the trigger and restart the remote once, or long press the "+" button to enter the trigger throttle calibration interface, and then follow the interface prompts to calibrate the trigger.

Other interfaces

1. Flight data interface

- a. Maximum speed
- b. Mileage
- c. Average power
- d. Power Consumption

2. Notification interface

The notification interface displays the details of notifications, prompts, exceptions, etc. that the user needs to know or handle. **When there is no such message, this interface will not appear.** When such a message exists, you can switch from other display interfaces to the notification interface by pressing the power button.

The notification interface will display the current notification, prompt, or exception messages. If there are multiple messages, you can press the "+" / "-" buttons to select one of them, and press the trigger to view the details of the selected item.

Some messages may require user operation, such as confirmation, cancellation, or no longer display. After opening the message details, you can select the operation method by using the "+" / "-" buttons, and press the trigger to confirm the operation.

3. Menu interface

In other interfaces, you can switch to the menu interface by short pressing the power button of the remote.

1) LED settings

LED Display Mode

LED Color

2) Flight Setting

Master Plus/Pro Plus/Max Plus equipped with flight assist function. Before using the flight assist function, please check the sensor under the front of the board to ensure that there is no foreign object attached to the sensor.

Setting operation steps:

1. When the trigger is locked, press the power button to switch to the menu interface.
2. Press the trigger once to enter the menu setting.
3. Press the "+" / "-" buttons as a navigation buttons to Flight Setting.
4. Flight assist is turned off by default and is in manual mode by default. First switch to flight assist to turn on the flight assist function.
5. Then navigate to flight altitude. After entering, you can switch between three flight altitudes: high, medium and low.
6. After setting, when using, the sensor will automatically stabilize the flight

altitude within the altitude range you set.

Tips:

It is recommended to use this function in calm conditions. Try to turn off this function in strong winds and waves.

3) Settings

- a. Time Setting
- b. Gear setting

The step can be set to 1, 2, 3 or 4. After setting, when you operate the "+" / "-" buttons in the control mode, one operation increases or decreases the gear of the corresponding step until the maximum or minimum gear is reached.

- c. Throttle calibration
- d. About

4) Bluetooth

After entering, scan the connectable Waydoo Flyer EVO boards and display the boards.

Tips: The remote menu interface will be adjusted with product updates.

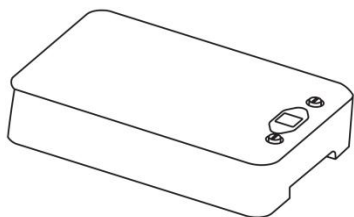

Powerflight Battery

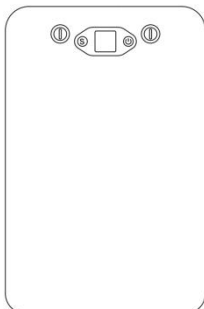

The Waydoo Powerflight Battery is designed specifically for the Waydoo Flyer EVO. The battery provides a safe, reliable and powerful energy source for the product. The battery is equipped with an LCD display to provide friendly human-computer interaction. The Powerflight Battery has two capacity options of 36Ah and 45Ah to meet users' various needs for weight and battery life. The battery adopts a wire-free design and is easy to install.

1. Powerflight Battery Button



-  Switch button (Long press in some interfaces to function as the return button)
-  Power button (Can function as the confirmation button in some interfaces)

2. Interface Introduction

1) Status bar

Screen	Status bar display content
Main interface	Current time, button operation sensor prompts
Other interfaces	Button operation sensor prompts, operation prompts

2) Main interface

Other interfaces will automatically return to the main interface if there is no operation for about 15 seconds.

Battery status	Main interface display content
Discharge/standby status	Power, voltage, current, discharge/standby status
Charging status	Battery power, battery temperature, charging current, charging status
Inverter discharge status	Battery power, discharge power, AC power parameters, AC power output switch

3) Other interfaces

Common settings interface

Message interface (if there is a message)

Menu interface

3. How to turn the battery on and off

1) Turn on the battery

When the battery is turned off, use a magnet to tap on the power button for 3 seconds, the battery will be awakened and the power-on logo screen will be displayed, followed by the power-on progress bar. When the progress bar shows completion, the battery main interface will be displayed, indicating that the power-on is successful.

- a. If the magnet moves out of the sensing height range (the sensing height is about 1 cm) during the power-on process, the power-on process will be interrupted and the screen will turn off.
- b. If the battery has been installed on the board or connected to the plug of the inverter charger, the battery will supply power to the outside after it is turned on.
- c. If the battery fails or is not connected to any device, the battery will not supply power to the outside after it is turned on.

2) Turn off the battery

When the battery is turned on and displayed on the main interface, tap the power button with a magnet for 3 seconds, the the power-off logo screen will be displayed, then the screen will turn off, and the battery will stop supplying power to the outside.

4. How to check the battery level

When the battery is turned off, use a magnet to short tap on the power button once to wake up the battery. When the battery displays the logo screen, the remaining battery level will be displayed. If there is no other operation within 5 seconds, the display will turn off.

When the battery is turned on and working normally, the battery display is always on, and you can directly check the remaining battery level.

Charger/Inverter Charger

To meet different usage scenarios of users, we provide two options: Powerflight Charger and Powerflight Inverter Charger.

Powerflight Charger

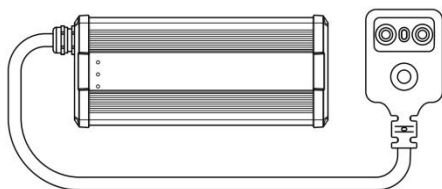

1. AC cord
2. DC cord
3. Charging start/stop button
4. Plug indicator light
5. Charger indicator light

Note: The charger is not waterproof. Please keep the charger dry and away from water during storage, transportation or use.

Charging safety tips:

Charging should be carried out in an environment free of flammable and explosive materials in the surrounding area. It is forbidden to charge in the children's activity area and sleeping area to avoid personal safety accidents!

Charger indicator light

1. Charger indicator light instructions

Indicator light status	Status description
Blue light is always on	Charger is in standby mode
Green light is flashing	Charging
Green light is always on	Fully charged
Red light is flashing	Charger is faulty

2. Charging cable plug indicator light instructions

Indicator light status	Status description
Breathing	Standby/Fully charged
Always on	Charging
Fast breathing	Maintenance

How to use Powerflight Charger

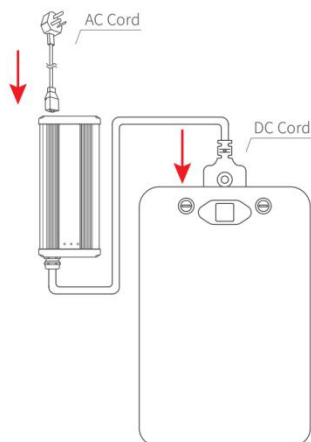

Tips: It is recommended to fully charge the battery when using it for the first time. Please use the official charger.

1. Place the Powerflight battery in a cool, dry place away from flammable or high-temperature items.
2. Connect the charger's DC cord to the battery, press the DC cord plug to ensure a secure connection, and then place the battery face up on the ground horizontally.
3. Connect the charger's AC cord to the charger and plug the AC cord into the wall outlet.
4. Press the charging start/stop button on the charger's DC cord once to start charging.
5. Once the battery is fully charged, the screen will automatically turn off.

Tips:

1. After charging starts, if the battery temperature is higher than 45°C, charging will not start. When the battery temperature drops below 45°C, charging will start. If the battery temperature is lower than 10°C, charging will not start. Please move the battery to a location with a suitable temperature. When the battery temperature rises above 10°C, charging will start.
2. If the battery is disconnected from the charger during charging, charging will stop and return to standby status.

How to Stop Charging

When the battery is in charging mode, press the charging start/stop button once, and then unplug the AC cord from the wall outlet to stop charging, and the battery display screen will turn off after awhile.

Tips: When the battery is charging, please do not unplug the DC plug from the battery directly to avoid damaging the charger or battery.

Battery charging maintenance

During the charging process, when the battery is in a state of excessive voltage difference between cells, the charging status will display maintenance. At this time, the user can stop charging and continue to use the battery. The maintenance will be completed when charging next time.

Powerflight Inverter Charger

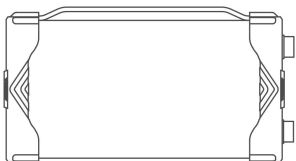

The Powerflight Inverter Charger can charge the Powerflight battery and can also connect the Powerflight battery to output AC power (110V/220V), so that users can use the Powerflight battery to power other electrical appliances outdoors. It has a stylish and compact appearance and is easy to carry.

Charging safety tips:

Charging should be carried out in an environment free of flammable and explosive materials in the surrounding area. It is forbidden to charge in the children's activity area and sleeping area to avoid personal safety accidents!

How to use the charging function

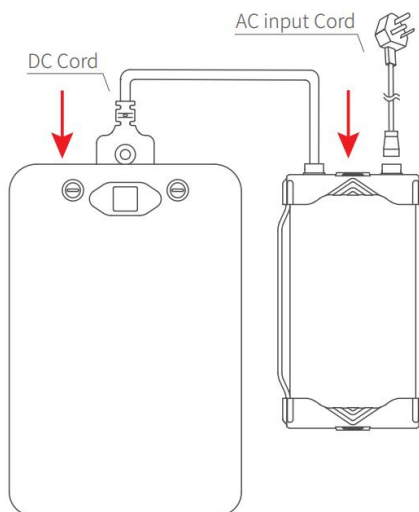

1. Place the Powerflight battery in a cool, dry place away from flammable or high-temperature items.
2. Connect the charger's DC cord to the battery, press the DC cord plug to ensure a secure connection, and then place the battery face up on the ground horizontally.
3. Connect the charger's AC input cord to the charger and plug the AC input cord into the wall outlet.
4. Press the charging start/stop button on the charger's DC cord once to start charging.

How to Stop Charging

When the battery is in charging mode, short press the charging start/stop button once, and then unplug the AC input cord from the wall outlet to stop charging, and the battery display screen will turn off after awhile.

Note: When the battery is charging, please do not unplug the DC cord from the battery directly to avoid damaging the inverter charger or battery.

How to use the inverter function

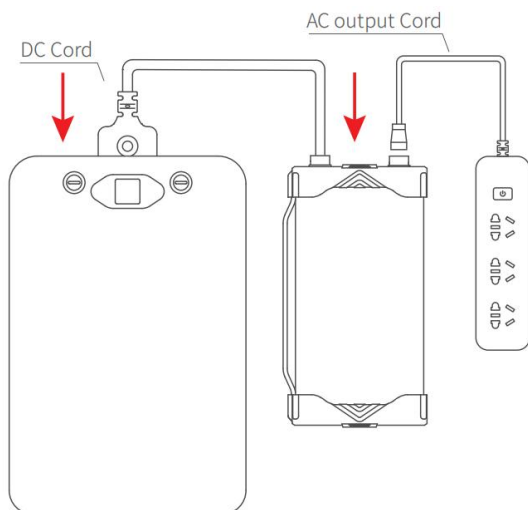

1. Connect the AC output cord to the AC port of the inverter charger and tighten the black round buckle clockwise.
2. Connect the DC cord to the DC port of the inverter charger and tighten the black round buckle clockwise, and connect the plug to the Powerflight battery.
3. After the battery is turned on, the main inverter interface is entered as shown in (a), which displays the currently set voltage and frequency. If the settings are correct, long press the charging start/stop button to start the inverter as shown in (b). If the voltage and frequency settings are incorrect, the powered device may work abnormally, be damaged, or even catch fire.

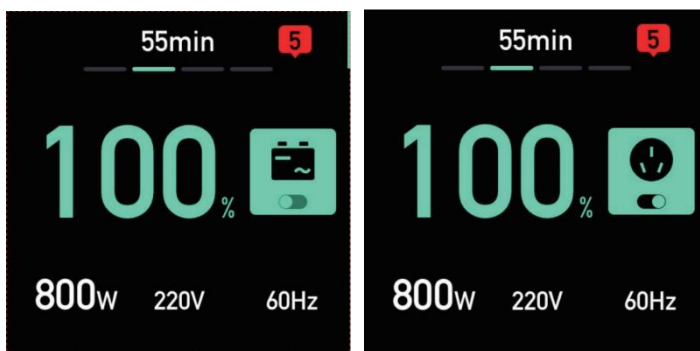

(a)

(b)

4. During the inverter process, short press the charging start/stop button once to stop the inverter.

Tips: During the inverter process, if the inverter charger detects that the load power of the external device exceeds 1500W for a long time, the battery will prompt overload protection and stop supplying power to the outside.

The main interface displays:

Whether the AC is in output status

The voltage type of the current connected socket (110V 220V)

The current output power

The second interface displays:

The output voltage of the AC

The output frequency of the AC

The current output voltage and current of the AC

The current fan speed of the inverter

Indicator Light Guide

1. Inverter Status Indicator Light Indication

Indicator Light Status	Indicator Light Indication
Breathing Blue Light	Standby status of charger mode, no DC output
Solid Blue Light	Working status of charger mode, with DC output
Breathing Green Light	Standby status of inverter mode, no AC output
Solid Green Light	Working status of inverter mode, with AC output

2. DC Cord Indicator Light Indication

Indicator Light Status	Indicator Light Indication
Breathing	Standby Status/Battery Fully Charged
Solid Light	Charging
Rapid Breathing	Maintenance Status

IV Assembly and use

4.1 Waydoo Flyer EVO Assembly

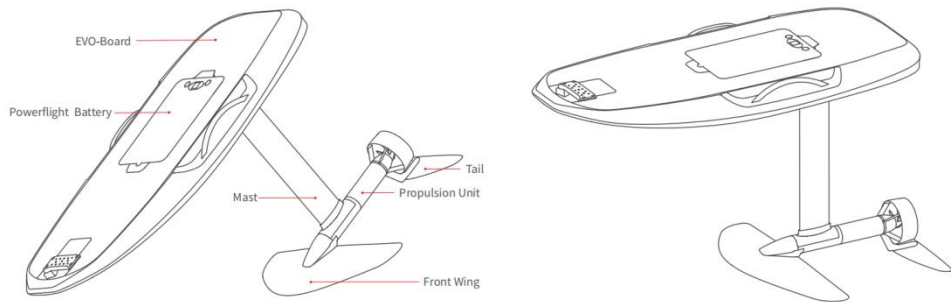

4.1.1 Inspection before assembly

1. Inspect the battery and mast power port terminals, ensuring that the terminals are tight, with no signs of rust or debris. Loose terminals (which can be tightened with tools), and abnormal appearance may cause severe heating of the terminals, leading to deformation of structural components and loss of waterproofness. It may also result in the overall battery life and power performance decline.
2. Check the sensor ports between DC ports, ensure it is free of any water and debris. Clean and dry it if necessary, otherwise the optical communication function of sensor will be affected.
3. Please check the battery rotary lock pin, make sure it is located in the groove.

4.1.2 Tool list

Slotted wrench, magnet, L-shaped wrench, electric screwdriver (optional)

Tips:

1. The L-shaped wrench is stored in the rubber plug of the battery compartment of the board. Please put it back into the rubber plug after use.
2. The electric screwdriver is not waterproof. Please keep your hands dry

when using it and avoid contact with water.

When the electric screwdriver locks the screw until it stops, the torque is about 5N.m. Please turn the handle manually until the electric screwdriver rotates by itself. When removing the screw, first turn the handle manually to loosen the screw, and then use the electric function.

4.1.3 Prepare the components

Mast, Propulsion unit, Powerflight battery, Board, Front wing (including 3 M6X35 mounting screws), Stabilizer wing (including 2 M6X20 mounting screws).

4.1.4 Assembly steps

Tips:

You can install the battery first or the mast first. If installing the mast first, it is recommended to install the front wing and stabilizer wing before installing the battery to ensure better support and stability during installation (if there are no wings, brackets can be used to provide support).

1. Battery Installation

Note: Before installing, please make sure the battery compartment and DC port is free of any water and debris. Check the sensor ports between DC ports, ensure it is free of any water and debris. Clean and dry it if necessary, otherwise the optical communication function of sensor will be affected.

1) Put the board on a flat ground with the Powerflight battery compartment side facing up. Lift the Powerflight battery with both hands and put it into the battery compartment carefully. Press Powerflight battery downward to ensure it is fully inserted into the board.

Tips: It is recommended to put the tail of the battery into the battery compartment first, and then install the battery handle side.

2) Use the slotted wrench on the remote wrist trap to press two round rotary locks on Powerflight battery, and rotate them clockwise about 90 degrees to tighten them.

3) Plug in the Rubber plug as shown below.

Note: An L-shaped wrench is placed here, please use it before plugging in the Rubber plug.

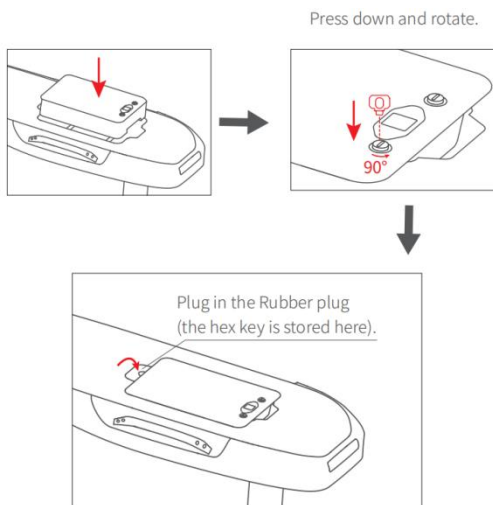

Battery Removal

1. Rotate two battery rotary locks 90° counterclockwise with a slotted wrench to the shown position.
2. Open the rubber plug, press the internal unlock switch, and lift the battery upward with both hands simultaneously.

Note: Please follow the above instructions step-by-step to avoid damaging the product.

2. Assemble the mast

- 1) Remove the three bolts that hold the rubber protective sleeve 1 on the propulsion unit, then remove this sleeve. Next step is to remove the rubber protective sleeve 2 locating at the connection of mast and propulsion unit. Apply grease on the sealing ring according to the actual situation.

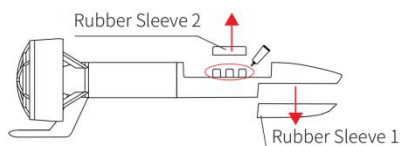

Note: Please keep the rubber protective sleeve properly to avoid loss.

2) Remove rubber protective sleeve on the mast and masthead.

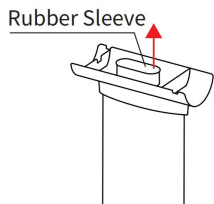

3) Insert the mast vertically downwards onto the propulsion unit. During the installation, moving the mast slightly left and right will make it easier to fit in place. Then fix and tighten it with two M6X20 bolts (Torque: 5-10N.m).

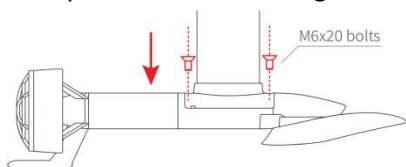

4) Turn the board over to insert the mast vertically into the mast installation hub.

5) Ensure the mast is installed correctly, and tighten it with two M6X20 bolts (Torque: 5-10N.m).

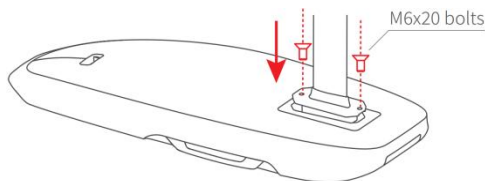

Note: It is not recommended to frequently disassemble the mast and propulsion unit to protect the connectors, and do not disassemble them unless necessary.

3. Install the front wing and stabilizer wing

1) Put the front wing on the propulsion unit front mount, use three M6X35 bolts, tighten it with a L-shaped wrench or electric screwdriver, torque 5-10 N.m.

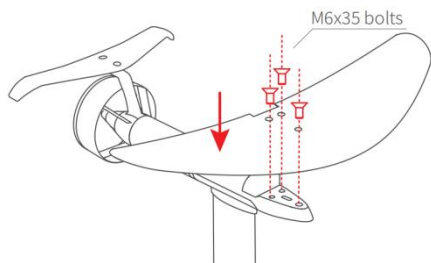

2) Attach the stabilizer wing on the propulsion unit stabilizer mount, use two M6X20 bolts, tighten it with a L-shaped wrench or electric screwdriver, torque 5-10 N.m.

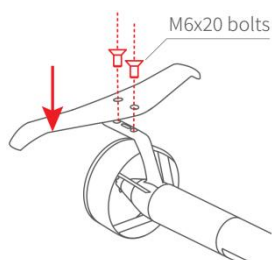

Tips:

- 1) The convex mounting position is designed to facilitate the wing installation.
- 2) When install stabilizer wing, its stability can be improved by using stabilizer wing extended rod.

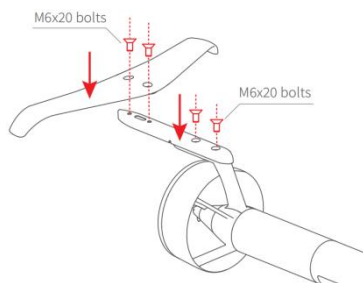

4. Turn on the remote/board

First turn on the remote, then turn on the Powerflight battery.

5. Connect the remote

If the remote does not connect to the board automatically, please pair them by taking steps below.

1. Press and hold the power button and the '-' button on the remote for 2 seconds to enter the Bluetooth connection management interface.
2. In this interface, press the '+' and '-' buttons on the remote to select the target board, and then press the remote trigger to confirm.
3. The Powerflight battery will pop up a confirmation prompt. Tap its power button with the magnet to confirm.
4. If the connection is successful, the Bluetooth icon on the remote status bar will light up and the remote indicator light will show green.

Tips: When the remote is already connected, the steps to pair a new remote are as follows:

1. First, turn off the currently connected remote.
2. Then follow the pairing steps for the board and the new remote to ensure that they are successfully connected.

4.2 How to use

After assembling the Waydoo Flyer EVO and preparing to use in the water, please follow the following suggestions and steps to help you stay safe during the use of the Waydoo Flyer EVO. Remember to make the necessary preparations in advance and ensure the safety of the surrounding environment to make the experience more enjoyable and safe.

Preparation and precautions:

1. Wear safety equipment: It is always recommended to wear a diving wet suit, diving shoes, diving gloves, life jacket and safety helmet during the use of the product to ensure safety.
2. Test the propeller: During the test phase before entering the water, the propeller will rotate at the lowest speed to ensure safety and protect the motor. Avoid your hands or any part of your body near the propeller during the rotation of the propeller.
3. Carry the board: Before carrying, please make sure that the remote is turned off or the trigger is locked. During the transportation, avoid touching the propeller with your hands and avoid bumping the wings, propeller and other parts.
4. Choose a suitable riding location: Choose a location with sufficient water depth, about 1.5 meters, without surface or underwater obstacles, away

from swimmers and other water activities, and ensure that local laws allow the use of eFoil in this area.

5. Maintain balance and safety: When you feel that you have lost your balance, please release the remote trigger first, and try to fall on the same side as the board is tilted to reduce potential injuries.

If you are ready to use in the water, it is recommended to follow the steps below:

Before boarding, please make sure the remote trigger is locked.

1. Getting familiar with the board: It is recommended that users climb up the board from the backside. Be careful not to kick the wings, propeller or the power unit (and other power components), you can use the board handle to assist in boarding.

(Recommendation: Have a person designated as a “spotter” when using this product to keep an eye on the rider.)

2. Set the gear: Set the suitable gear. It is recommended that beginners start from gear 1. Long press the "-" button of the remote to unlock the remote. Slowly press the trigger to start the propeller.

3. Slow gliding practice: Slowly increase the throttle to gradually accelerate the board. If the head of the board is tilted higher during the process, it means that the throttle is too large. You can move your body forward or reduce the throttle appropriately. When the riding posture is suitable, you can start to take off.

4. Adjust riding posture: After taking off, adjust the height and direction of riding by adjusting the center of gravity and throttle.

Control Guide (recommended to learn before use):

Adjusting the flight attitude, controlling the altitude and direction are the key parts of using the board. The following are some basic control method guidelines that require training and practice to master (assuming the user is facing the front of the board).

1. Throttle control speed: Add/subtract throttle to adjust the speed.

2. Function of front wing and stabilizer wing: Provide lift and stability. The faster the speed, the greater the lift and stability.
3. Center of gravity adjustment: Adjust the center of gravity left/right/forward/backward to tilt, turn or adjust the pitch of the board.
4. Takeoff control: When the speed and pitch attitude are appropriate, the board can take off the water relying on the lift of the wing.

When using the board, please pay attention to the following:

1. Wireless signal connection: To maintain a good wireless signal connection, please keep the front of the board out of the water as much as possible.
2. Beginner training: Beginners need time to master the usage. It is recommended to practice more to gradually master the skills.

Hopefully, the above guidelines and suggestions can help you use your Waydoo Flyer EVO more safely and smoothly.

V Troubleshooting

If there are any problems during use, stop operating the product, lay on the board, and paddle with your hands until you return to land. After the problem is solved, you can use the board again. If there is any problem that cannot be solved, contact the after-sales service in time.

VI Maintenance

This product requires regular care and maintenance to ensure it remains in good working condition and to prevent accidental damage. Please refer to the detailed guidelines below to understand and become familiar with the maintenance and storage instructions for the relevant components.

Clean and maintain the product immediately after use. Please note that the power unit should be cleaned with water. All components of the product should be kept out of direct sunlight except during use.

Powerflight Battery

Check before use

1. Please read the instructions on the warning sticker on the battery carefully before daily use.
2. Please carefully check whether the Powerflight Battery is in good condition with its appearance before use. Using an defect battery may cause battery damage, electric shock, fire, injury, and property loss.
3. Please make sure to install the battery on the board and connect it with the power unit, and do a power-on test and various functional checks. Before launching, check if the battery works well on power on/off, Bluetooth pairing, indicator lights display and other functions.

Cleaning and maintenance after use

1. After using, please be sure to turn off the remote and battery first. After both are closed, disassemble the battery, power unit, front and stabilizer wings and place them in a safe and suitable place.
2. Clean the battery and rinse its surface with water. Use a cotton swab dipped with alcohol to clean the battery DC ports and buttons. Then carefully wipe the battery with a dry towel and place it in a dry, cool environment to remove any remaining moisture. The Powerflight Battery is highly water resistant, but should be kept as dry as possible and never be soaked when not in use.
3. Please avoid placing the battery directly on sand, as its surface could be scratched.

4. Do not charge the battery immediately after use. It may be hot after use. Allow some time after use and between charging to cool it down to room temperature. It is recommended to place it in a cool environment.

5. Do not use denatured or expired alcohol or other flammable solvents to clean the Powerflight Battery or Charger.

* If the battery accidentally drops or is damaged during this process, please contact the Waydoo After-sales Service Team immediately and do not continue to use the battery.

Periodic maintenance

1. Regularly check the appearance, ports, indicators and other parts of the battery for good condition every 2 months. Pay more attention to the cleaning and inspection of the battery positive and negative terminals. It is recommended to use a cotton swab dipped in alcohol to remove corrosion. Clean and maintain the battery ports in time to prevent the inner metal contact connectors from corrosion affects the stability of communication. The connector in the DC port of some versions of the battery can be replaced. Please contact the Waydoo After-sales Service Team or your local authorized service center if needed.

2. Please check the battery power, power supply, and other functions monthly. Use a magnet to tap the power button once to check the remaining power. If the power is too low, please charge the battery in time to keep it at 40-60% to avoid over discharge.

3. Regularly check the valve of the battery once a month for any damage Please do not continue to use the battery if the valve is broken.

4. Regularly inspect the battery terminals. If the terminals are corroded, replace them promptly to prevent any impact on the battery's functionality

Battery power terminal health monitoring:

When using the battery for an extended period, regularly clean and maintain the power terminals to effectively extend their lifespan and prevent oxidation and corrosion. Oxidation of the terminals can cause poor contact, increase resistance, and raise the temperature of the battery terminals during discharge. If the temperature exceeds the safe range, it may damage the battery. The battery output will immediately be interrupted and a warning window will pop up. In this situation, please replace the battery terminals and inspect them before continuing to use the

battery.

* If the battery is accidentally damaged in appearance or function, please contact the Waydoo After-sales Service Team immediately, and do not continue to use the battery.

Tips

1. If the battery is not installed in place and the battery is turned on without locking the battery lock, seawater will enter between the power plugs, resulting in poor plug contact, causing electrical corrosion and even burning the battery and mast plugs.
2. When installing or replacing the battery, avoid seawater between the plugs, otherwise it will cause product malfunctions.
3. Do not use WD40 or other insulating substances to spray each power interface, as it will cause poor contact.
4. Rinse with fresh water after use and charge when the plug is dry to avoid electrical corrosion of the plug causing failure to charge.

Safe storage

- (1) Place the Powerflight Battery in a safe place and avoid contact with children or animals.
- (2) Do not leave the Powerflight Battery in the car, especially on hot days.
- (3) Do not disassemble, puncture, impact, or drop the Powerflight Battery.
- (4) Do not handle the Powerflight Battery with wet hands.
- (5) Do not expose the Powerflight Battery to direct sunlight, fire, or place it in an environment where the temperature exceeds 45°C (113°F).
- (6) Do not discard the Powerflight Battery randomly.
- (7) If you need to store the Powerflight Battery for more than one month, maintain the battery level at 40-60%.
- (8) It is recommended to store the battery in a battery safety box, a battery fireproof bag, or a specific safety container.

Power Unit

Check before use

- (1) Please carefully check the entire Power Unit for good appearance and function before use. Using a defected mast may cause damage to the battery or mast, electric shock, fire, and even injury or property loss.

(2) Please carefully check the DC port on the top seat of the mast, the middle support rod and the corresponding connection, the motor body, the wing mounting hole, the wing mounting adapter, etc., to ensure that the Power Unit will work without any difference or damage.

(3) Check the status of the grease on the sealing rings of the power port and ESC port of the mast. Apply an appropriate amount of sealing ring lubricant silicone grease to ensure lubrication and prevent rust.

(4) Please carefully check the propeller and protective cover, pin, motor shaft and other PTO components to prevent corrosion or damage. If the motor shaft or pin are corroded, it is recommended to use a rust remover for cleaning and maintenance. If any part of the Power Unit is different or damaged, please stop using it and contact the Waydoo After-sales Service Team in time.

Cleaning and maintenance after use

(1) After using the eFoil, please make sure to turn off the battery completely first. Then disassemble the battery, power unit, front and stabilizer wings and place them in a safe and suitable place, preferably in a cool place.

(2) Please carefully check the overall appearance of the Power Unit, propeller and other components to ensure that there is no obvious impact or damage caused by use. If there is serious damage, please contact the Waydoo After-sales Service Team in time.

(3) When cleaning the Power Unit, please rinse the main body of the mast with fresh water for about 1 minute to ensure that there is no seawater or other impurities left on the main body to prevent corrosion. Rinse the mast top seat to ensure that the mast top seat is clean and free of debris. Rinse and clean the DC port with fresh water, then wipe with alcohol swab to ensure there is dry and free of debris. Clean the motor, propeller cover, propeller and other places with fresh water to ensure any salt, sand or other debris is removed.

(4) After fully cleaning the Power Unit, wipe it carefully with a dry towel, and then place it in a dry and cool environment to remove the remaining moisture.

(5) After drying, remove the propeller cover, propeller and propeller pin, and check whether they are in good condition. If there is corrosion on the pin or the motor shaft, it is recommended to use a rust remover for cleaning and maintenance, and then install it back to the corresponding position.

Periodic maintenance

- (1)When the eFoil is not in use, please remove the Power Unit from the board and put it back in the package for storage.
- (2)Regularly clean the wings, power unit, propeller and propeller pin, etc., and use lubricants or rust removers to maintain specific parts. It is recommended to check and clean once a month.

Tips

- (1)Please do not use the product in waters with a lot of impurities to prevent the propeller from being entangled and stuck by foreign objects, which may damage the propeller or even burn out the ESC and motor.

Safe storage

- (1)Please make sure to always store the Power Unit in a clean, dry environment.
- (2)Place the Power Unit in a safe place and avoid contact with children or animals.
- (3)If it will not be used for a long time, please be sure to store the power unit in the corresponding storage bag.

3. Board

Check before use

- (1)Please carefully check the appearance of the board before use to ensure that there is no obvious damage that will affect the use.
- (2)Please carefully check the handle, battery compartment, battery compartment rubber plug, mast mounting base and other parts before use to ensure that there is no damage that will affect the use.

Cleaning and maintenance after use

- (1)Please be sure to disassemble the battery, power unit, front and stabilizer wings in sequence and place them in a safe and suitable place.
- (2)Rinse the board with fresh water for about 1 minute, clean the battery compartment and the mast mounting base, and ensure that there are no salt, sand and other debris left, prevent water from entering and corroding the board's pipes. Then dry with a towel and let sit in a cool dry place to remove remaining moisture. EPP material has some water absorption properties. After rinsing, place it vertically in a cool, dry area and wait for it to dry before storing

Periodic maintenance

(1) Regularly apply a lubricant/rust remover to the mast mounting base and screw holes for proper maintenance. Remember to keep substances such as lubricants away from the handles of the board to avoid slippage.

(2) It is necessary to check whether the board is damaged or cracked regularly, and it is recommended to check it once every 3 months. If there is serious damage, please stop using the board and contact the Waydoo After-sales Service Team in time.

Safe storage

(1) Make sure that all residues like sand, grit, dirt and salt are rinsed off with clean water and that the board is sufficiently dry.

(2) Before storing, please make sure the board and the handle are dry.

4. Remote

Check before use

Please carefully check the appearance of the entire remote before use, and check whether the functions of the remote are normal after powering on and connecting to the board, to ensure that there are no obvious faults that will affect the use.

Cleaning and maintenance after use

(1) Please be sure to turn off the remote first.

(2) Rinse with fresh water to remove salt and debris, paying special attention to the trigger position when cleaning the remote. If you notice it sticking when you pull the trigger, check for gravel or sand inside the trigger. If so, rinse the trigger area intensively with clean water while depressing and releasing the trigger several times at the same time.

(3) After washing thoroughly, dry it with a towel and store the remote in a cool and dry place.

Periodic maintenance

Regularly check the functions of the remote such as power-on, charging, Bluetooth connection, buttons, and trigger.

Tips

(1)After each use, the remote should be rinsed with fresh water and charged when the charging ports are dry to avoid electrical corrosion of the charging ports and failure to charge.

Safe storage

(1)Make sure that all residues of sand, grit, dirt and salt are rinsed off with clean water and fully dried.

(2)Store in a cool dry place out of direct sunlight. When not in use for a long time, it is recommended to put the remote back into the package.

5. Powerflight Charger/Inverter Charger

Check before use

Please carefully check the appearance of the entire charger (Inverter Charger) before use to ensure that there is no obvious damage or other differences.

Cleaning and maintenance after use

(1)Please be sure to unplug the charger to cut off the power supply.

(2)After charging the battery, please check if there is any difference in the connectors at both the battery's DC port and charger's DC cable.

Periodic maintenance

Regularly check the connectors, wires, buttons, indicator lights and other functions/components of the charger, and check various functions after connecting with the battery.

Safe storage

Please be sure to store the charger in a cool, dry place out of direct sunlight. When not in use for a long time, it is recommended to put the charger back into the original package.

Note: The charger is not waterproof. During storage, transport, or use, keep the charger dry and away from water sources.

6. Wings

Tips

(1) Please use the screws in the official accessory package to install the wings. Avoid screws that are too long or too short to install the wings in place and damage the wings and wing adapters.

(2) The wings should be removed after each use and rinsed with fresh water to avoid salt accumulation and corrosion of the mast caused by drying of sea water.

7. Propeller

Regularly check the condition of the propeller. If your propeller is damaged and needs to be replaced, please follow the below steps to replace it.

Tool: Flat wrench

1. Turn the propeller protective cover clockwise to remove it from the propeller guard.
2. Remove the bullet. Unscrew it from the motor shaft with an Flat wrench, and remove the current propeller.
3. Remove the current propeller pin and replace it with a new pin. Insert the pin into the cross hole located on the propeller shaft at the motor output. Center the pin on the motor shaft.
4. Reassemble the propeller: Take a new propeller (confirming that it has no defects such as deformation or scratches), and assemble the propeller. Note that the direction of the propeller groove should be consistent.
5. Reassemble the new bullet and the propeller protective cover, and the propeller replacement is done.

VII Warranty Terms

Waydoo Flyer EVO After-Sales Service Policy/Terms

Warranty service coverage:

Waydoo warrants the original buyer for the warranty period that the product will be free from material and workmanship defects under normal use in accordance with Waydoo eFoil's published product materials. The warranty period starts from the date you received the Waydoo products. Please refer to Appendix I for the specific coverage period on each part. The repair or replacement of parts, under this warranty, does not extend the life of this warranty beyond its original expiration date. If you cannot provide a receipt or other valid proof of purchase, the start date of the warranty period will refer to the dispatch date of the Waydoo product, unless otherwise stipulated by Waydoo.

How Do I Get After-Sales Service?

If a product does not function as guaranteed during the warranty period, you may obtain after-sales service by contacting Waydoo After-Sales Support.

Waydoo may not provide after-sales service in some regions. The after-sales service policy may vary from region to region. Charges may apply for services not covered by this Limited Warranty. For information specific to your location, please contact Waydoo or your local authorized dealers.

What Should I Do Before Getting Warranty Service?

To obtain warranty service, you must first contact Waydoo and describe the problem in detail as clearly as possible. Waydoo will first attempt to diagnose and resolve your problem by remote supporting , like telephone, e-mail. If your problem cannot be resolved over remote supporting, you may be required to deliver the product to Waydoo or local authorized service center for further examination. Waydoo will arrange for repair or replacement according to the warranty services applicable to the product.

Before obtaining after-sales service for your product, please read the following service information:

√ Follow Waydoo's service process.

✓ Agree that Waydoo shall not be held responsible for loss or disclosure of any data, including confidential information, proprietary information, or personal information, contained in the returned product.

✓ Provide Waydoo with sufficient and safe access to your product, so Waydoo can provide service as needed.

✓ Remove all functional parts, additional parts, alterations, modified parts and attachments not covered under this limited warranty.

✓ Ensure that the product or part is free of any legal restrictions that prevent its replacement.

Replacement of Product and Part

When after-sales service involves the replacement of a product or part, the replacement item becomes your property and the replaced item becomes Waydoo's property. Only unaltered Waydoo products and parts are eligible for replacement.

Replacement products or parts may not be new, but they will be in good working order and at least functionally equivalent to the products or parts replaced. A replacement product or part shall be covered for the time remaining in the original product's warranty and bound to a new serial number.

Use of Personal Contact Information and Data

If you obtain service under this policy, you authorize Waydoo to store, use, and process your contact information, including name, phone number, address, and e-mail address. You agree and understand that it is necessary for Waydoo to collect, process and use your data to perform service under this policy. We may contact you for service, and may also inquire about your satisfaction with our service or to notify you about any product recalls or safety issues. To achieve these aims, you authorize Waydoo to transfer your information to any country where we do business and to provide it to entities acting on our behalf. We may also disclose your information where required by law.

What is NOT Covered by This After-Sales Policy?

Parts not specified in the APPENDIX 1 that are covered by this limited warranty.

× Changes in appearance or damage caused by normal wear and tear, color change, etc.

- × Damage caused by unauthorized modification, disassembly not in accordance with official instructions or manuals.
- × Damage caused by improper setup, installation, incorrect use, or operation not in accordance with official instructions or manuals.
- × Damage or loss of components caused by cleaning the products or parts not in accordance with official instructions or manuals.
- × Damage caused by any water activities conducted without following the instructions in the manual.
- × Damage caused by unauthorized modification, disassembly not in accordance with official instructions or manuals.
- × Collisions or burn incidents caused by human factors unrelated to the product's inherent quality issues.
- × Damage caused by circuit modifications not guided by official instructions, or improper use of battery packs and adapters.
- × Damage caused by operation in inclement weather (i.e. strong winds, rain, sand/dust storms, direct sunlight, etc.).
- × Product malfunctions or damage caused by operation in complex electromagnetic environments or areas with strong interference sources, such as mining areas, high-voltage lines, substations, underwater rocks, or unsuitable water environments.
- × Damage caused by a forced operation when components have aged or been damaged.
- × Damage caused by operation in environments where there is interference from other devices.
- × Damage caused by reliability or compatibility issues when using unauthorized third-party parts.
- × Battery damage caused by excessive discharge.
- × Further damage caused by continued use of the product after reporting a fault.
- × Evidence of tampering or removal of the device's serial number, factory label, or other identifiers.
- × Warranty rights are non-transferable and apply only to the original purchaser.
- × Issues determined by Waydoo to be not due to manufacturing defects, and the purchaser cannot provide valid proof of the source of the problem.
- × Failure to send the corresponding item within the specified time after confirming warranty service with Waydoo or an authorized Waydoo dealer.

Disclaimer

√ Limited Warranty policies and related costs may vary with respect to the local laws, the corresponding Waydoo service in different countries/regions where Waydoo product is purchased in.

√ You may need to send the faulty product(s) back to Waydoo or a Waydoo authorized service center. Waydoo will examine the returned product(s) to identify the problem and the responsibility upon receipt of the product(s). If the problem qualifies for service under this Limited Warranty policy, Waydoo will bear the cost for repair or replacement. Customer is responsible for all shipping costs.

√ If Waydoo determines that the issue in question is not covered by this Limited Warranty policy, you will have to apply for Customer Paid Repair Service or request Waydoo to return the product(s). Waydoo will not start repair until you agree to the cost for repair quoted by Waydoo. If you disagree with the cost for repair, Waydoo may return the product(s) with you burdening the cost of return shipping.

√ If the issue with the product is not covered under warranty (e.g., damage caused by human factors), Waydoo will charge fees for inspection, replacement parts, testing, labor, and shipping, as applicable.

√ Given the variability of Waydoo's after-sales service policy in different countries/regions, Waydoo does not provide global warranty, generally customers can obtain warranty service only at a designated Waydoo authorized service center in the region where he/she purchased the product(s). However, depending on part availability and inventory status, customers can obtain cross-regional repair service at an additional charge in an authorized repair center but Waydoo will handle the customer's request at its discretion.

√ Customer is responsible for losses incurred from providing incorrect or invalid delivery address, or refusing to signing for the delivery.

√ If the user uses Waydoo products for non-officially authorized commercial purposes, Waydoo reserves the right to set additional warranty conditions.

√ If the user's region or country is subject to service restrictions due to force majeure or other objective factors, Waydoo reserves the right to charge the user for certain necessary fees.

√ If the user is unable to provide sufficient evidence, leading to Waydoo's inability to verify the warranty compliance of the faulty parts, Waydoo reserves the right to refuse free warranty service.

√ If you wish to return the product internationally, you must obtain prior consent from Waydoo, and you are responsible for any customs duties and clearance fees incurred.

√ If the product is extremely damaged, its performance may be severely affected and will be beyond repair. In this case, Waydoo will not be able to provide repair service.

√ Before sending the product for repair, please remove any personalized items and decorations attached to the original product (including but not limited to decorative stickers, UAS stickers, paint, etc.). Waydoo is not responsible for any damage to or loss of personalized items and decorations.

√ To ensure your rights, please check the product for any damage (including damage caused by logistics, etc.) upon receipt. If you find any issues, report them within 3 calendar days of receipt. Otherwise, the product will be considered as received in undamaged condition with normal performance and complete parts. According to the logistics claims management process, damage caused during transport must be reported to Waydoo or an authorized Waydoo service center within 24 hours, otherwise, claims cannot be processed.

Limitation of Liability

Waydoo is only responsible for the loss or damage of the product under the following conditions: the product is owned by Waydoo, or the product is in transit under Waydoo's responsibility.

Waydoo is not responsible for any loss or leakage of data contained within the product, including confidential information, proprietary information, or personal information. The following clause may be invalid:

If the cause of data loss or leakage is due to our inadequate data storage technology, meaning we failed to fulfill reasonable management obligations, then despite the above clause, users may still hold us accountable.

If the cause of data loss or leakage is due to the user's own actions, such as casually discarding old products, we will not be responsible for such incidents.

For the following situations, regardless of whether any remedy specified in this document achieves its fundamental purpose, and regardless of whether

the claim is based on contract, warranty, negligence, strict liability, or other theories of liability, Waydoo and its affiliates, suppliers, distributors, or service providers will not be liable, even if the possibility of such situations was known:

Claims for damages made by third parties against you.

Loss, damage, or leakage of your data.

Special, incidental, indirect, or consequential damages, including but not limited to losses related to profits, business income, goodwill, or anticipated savings. Regardless of the cause of damage, the total liability of Waydoo and its affiliates, suppliers, distributors, or service providers is limited to the direct losses actually suffered by you and shall not exceed the amount paid for the product.

These limitations do not apply to personal injury (including death) for which Waydoo is legally responsible, and compensation for loss of real and tangible property. Certain countries or jurisdictions may not allow exclusions or limitations for incidental or consequential damages, so the above limitations may not apply to you.

Your Other Rights

This Limited Warranty provides you with extra and specific legal rights. You may have other rights according to the applicable laws of your state or jurisdiction. You may also have other rights under a written agreement with Waydoo. Nothing in this Limited Warranty affects your statutory rights, including rights of consumers under laws or regulations governing the sale of consumer products that cannot be waived or limited by agreement.

For technical support or related inquiries, please send emails to support@waydootech.com or contact local authorized dealers.

APPENDIX 1 - WARRANTY PERIOD OF KEY PARTS

Part	Northern America	Europe	Australia	New Zealand	Other countries or areas
Board	1 year	1 year	1 year	1 year	1 year
Mast	1 year	2 years	2 years	1 year	1 year
Propulsion Unit	1 year	2 years	2 years	1 year	1 year
Front Wing	6 months	6 months	6 months	6 months	6 months
Stabilizer Wing	6 months	6 months	6 months	6 months	6 months
Powerflight Battery	12 months and less than 300 battery cycle	24 months and less than 300 battery cycles	24 months and less than 300 battery cycles	12 months and less than 300 battery cycles	12 months and less than 300 battery cycles
EVO Remote	1 year	2 years	2 years	1 year	1 year
Powerflight Charger	1 year	2 years	2 years	1 year	1 years
Powerflight Invertable Charger	1 year	2 years	2 years	1 year	1 years
 Scooter Kit	1 year	1 year	1 year	1 year	1 year

* The actual components are subject to the purchased product.

* Components not specified in the official warranty form as eligible for valid warranty are not covered by this warranty policy.



Waydo Technical Support

This guide may be updated without notice.

Check the official Waydo website for the latest version.

www.waydotech.com